

DALLAS
SEMICONDUCTOR

DS1345YL/BL
1024K Nonvolatile SRAM
with Battery Monitor

NOT RECOMMENDED FOR NEW DESIGNS. SEE DS1345Y/AB DATA SHEET.

FEATURES

- Built-in lithium battery provides more than 10 years of data retention
- Data is automatically protected during V_{CC} power loss
- Power supply monitor resets processor when V_{CC} power loss occurs and holds processor in reset during V_{CC} ramp-up
- Battery monitor checks remaining capacity daily
- Read and write access times as fast as 70 ns
- Unlimited write cycle endurance
- Typical standby current 50 μ A
- Upgrade for 128K x 8 SRAM, EEPROM or Flash devices
- Lithium battery is electrically disconnected to retain freshness until power is applied for the first time
- Full $\pm 10\%$ V_{CC} operating range (DS1345YL) or optional $\pm 5\%$ V_{CC} operating range (DS1345BL)
- Low Profile Module package fits into standard 68-pin surface mountable PLCC sockets
- Optional industrial temperature range of -40°C to $+85^{\circ}\text{C}$, designated IND

DESCRIPTION

The DS1345 1024K Nonvolatile SRAMs are 1,048,576-bit, fully static, nonvolatile SRAMs organized as 131,072 words by eight bits. Each NV SRAM has a self-contained lithium energy source and control circuitry which constantly monitors V_{CC} for an out-of-tolerance condition. When such a condition occurs, the lithium energy source is automatically switched on and write protection is unconditionally enabled to prevent data corruption. Additionally, the DS1345 devices have

PIN ASSIGNMENT

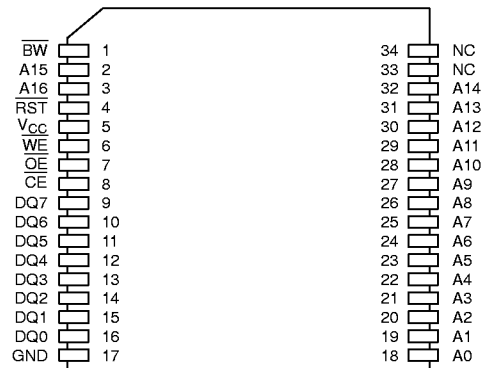

34-PIN LOW PROFILE MODULE (LPM)

PIN DESCRIPTION

A0–A16	– Address Inputs
DQ0–DQ7	– Data In/Data Out
$\overline{\text{CE}}$	– Chip Enable
$\overline{\text{WE}}$	– Write Enable
$\overline{\text{OE}}$	– Output Enable
$\overline{\text{RST}}$	– Reset Output
$\overline{\text{BW}}$	– Battery Warning Output
V_{CC}	– +5 Volts
GND	– Ground
NC	– No Connect

dedicated circuitry for monitoring the status of V_{CC} and the status of the internal lithium battery. There is no limit on the number of write cycles which can be executed, and no additional support circuitry is required for micro-processor interfacing. The devices can be used in place of 128K x 8 SRAM, EEPROM or Flash components. Available in the Low Profile Module package, DS1345 devices are specifically designed for surface mount applications.

READ MODE

The DS1345 devices execute a read cycle whenever \overline{WE} (Write Enable) is inactive (high) and \overline{CE} (Chip Enable) and \overline{OE} (Output Enable) are active (low). The unique address specified by the 17 address inputs ($A_0 - A_{16}$) defines which of the 131,072 bytes of data is to be accessed. Valid data will be available to the eight data output drivers within t_{ACC} (Access Time) after the last address input signal is stable, providing that \overline{CE} and \overline{OE} (Output Enable) access times are also satisfied. If \overline{OE} and \overline{CE} access times are not satisfied, then data access must be measured from the later occurring signal (\overline{CE} or \overline{OE}) and the limiting parameter is either t_{CO} for \overline{CE} or t_{OE} for \overline{OE} rather than address access.

WRITE MODE

The DS1345 devices execute a write cycle whenever the \overline{WE} and \overline{CE} signals are in the active (low) state after address inputs are stable. The later occurring falling edge of \overline{CE} or \overline{WE} will determine the start of the write cycle. The write cycle is terminated by the earlier rising edge of \overline{CE} or \overline{WE} . All address inputs must be kept valid throughout the write cycle. \overline{WE} must return to the high state for a minimum recovery time (t_{WR}) before another cycle can be initiated. The \overline{OE} control signal should be kept inactive (high) during write cycles to avoid bus contention. However, if the output drivers are enabled (\overline{CE} and \overline{OE} active) then \overline{WE} will disable the outputs in t_{ODW} from its falling edge.

DATA RETENTION MODE

The DS1345BL provides full functional capability for V_{CC} greater than 4.75 volts and write protects by 4.5 volts. The DS1345YL provides full functional capability for V_{CC} greater than 4.5 volts and write protects by 4.25 volts. Data is maintained in the absence of V_{CC} without any additional support circuitry. The nonvolatile static RAMs constantly monitor V_{CC} . Should the supply voltage decay, the NV SRAMs automatically write protect themselves, all inputs become "don't care," and all outputs become high impedance. As V_{CC} falls below approximately 2.7 volts, the power switching circuit connects the lithium energy source to RAM to retain data.

During power-up, when V_{CC} rises above approximately 2.7 volts, the power switching circuit connects external V_{CC} to the RAM and disconnects the lithium energy source. Normal RAM operation can resume after V_{CC} exceeds 4.75 volts for the DS1345BL and 4.5 volts for the DS1345YL.

SYSTEM POWER MONITORING

DS1345 devices have the ability to monitor the external V_{CC} power supply. When an out-of-tolerance power supply condition is detected, the NV SRAMs warn a processor-based system of impending power failure by asserting \overline{RST} . On power up, \overline{RST} is held active for 200 ms nominal to prevent system operation during power-on transients and to allow t_{REC} to elapse. \overline{RST} has an open-drain output driver.

BATTERY MONITORING

The DS1345 devices automatically perform periodic battery voltage monitoring on a 24 hour time interval. Such monitoring begins within t_{REC} after V_{CC} rises above V_{TP} and is suspended when power failure occurs.

After each 24 hour period has elapsed, the battery is connected to an internal $1M\Omega$ test resistor for one second. During this one second, if battery voltage falls below the battery voltage trip point (2.6V), the battery warning output \overline{BW} is asserted. Once asserted, \overline{BW} remains active until the module is replaced. The battery is still retested after each V_{CC} power-up, however, even if \overline{BW} is active. If the battery voltage is found to be higher than 2.6V during such testing, \overline{BW} is de-asserted and regular 24-hour testing resumes. \overline{BW} has an open-drain output driver.

FRESHNESS SEAL AND SHIPPING

Each DS1345 is shipped from Dallas Semiconductor with its lithium energy source disconnected, guaranteeing full energy capacity. When V_{CC} is first applied at a level greater than V_{TP} , the lithium energy source is enabled for battery backup operation.

ABSOLUTE MAXIMUM RATINGS*

Voltage On Any Pin Relative To Ground	-0.3V to +7.0V
Operating Temperature	0°C to 70°C, -40°C to +85°C for IND parts
Storage Temperature	-40°C to +70°C, -40°C to +85°C for IND parts
Soldering Temperature	260°C For 10 seconds

* This is a stress rating only and functional operation of the device at these or any other conditions above those indicated in the operation sections of this specification is not implied. Exposure to absolute maximum rating conditions for extended periods of time may affect reliability.

RECOMMENDED DC OPERATING CONDITIONS(t_A: See Note 10)

PARAMETER	SYMBOL	MIN	TYP	MAX	UNITS	NOTES
DS1345BL Power Supply Voltage	V _{CC}	4.75	5.0	5.25	V	
DS1345YL Power Supply Voltage	V _{CC}	4.5	5.0	5.5	V	
Logic 1	V _{IH}	2.2		V _{CC}	V	
Logic 0	V _{IL}	0.0		0.8	V	

(V_{CC}=5V ± 5% for DS1345BL)**DC ELECTRICAL CHARACTERISTICS**(t_A: See Note 10) (V_{CC}=5V ± 10% for DS1345YL)

PARAMETER	SYMBOL	MIN	TYP	MAX	UNITS	NOTES
Input Leakage Current	I _{IL}	-1.0		+1.0	μA	
I/O Leakage Current CE ≥ V _{IH} ≤ V _{CC}	I _{IO}	-1.0		+1.0	μA	
Output Current @ 2.4V	I _{OH}	-1.0			mA	14
Output Current @ 0.4V	I _{OL}	2.0			mA	14
Standby Current CE = 2.2V	I _{CCS1}		200	600	μA	
Standby Current CE = V _{CC} -0.5V	I _{CCS2}		50	150	μA	
Operating Current	I _{CCO1}			85	mA	
Write Protection Voltage (DS1345BL)	V _{TP}	4.50	4.62	4.75	V	
Write Protection Voltage (DS1345YL)	V _{TP}	4.25	4.37	4.5	V	

CAPACITANCE(t_A= 25°C)

PARAMETER	SYMBOL	MIN	TYP	MAX	UNITS	NOTES
Input Capacitance	C _{IN}		5	10	pF	
Input/Output Capacitance	C _{I/O}		5	10	pF	

(V_{CC}=5V ± 5% for DS1345BL)**AC ELECTRICAL CHARACTERISTICS**(t_A: See Note 10) (V_{CC}=5V ± 10% for DS1345YL)

PARAMETER	SYMBOL	DS1345BL-70 DS1345YL-70		DS1345BL-100 DS1345YL-100		UNITS	NOTES
		MIN	MAX	MIN	MAX		
Read Cycle Time	t _{RC}	70		100		ns	
Access Time	t _{ACC}		70		100	ns	
$\overline{\text{OE}}$ to Output Valid	t _{OE}		35		50	ns	
$\overline{\text{CE}}$ to Output Valid	t _{CO}		70		100	ns	
$\overline{\text{OE}}$ or $\overline{\text{CE}}$ to Output Active	t _{COE}	5		5		ns	5
Output High-Z from Deselection	t _{OD}		25		35	ns	5
Output Hold from Address Change	t _{OH}	5		5		ns	
Write Cycle Time	t _{WC}	70		100		ns	
Write Pulse Width	t _{WP}	55		75		ns	3
Address Setup Time	t _{AW}	0		0		ns	
Write Recovery Time	t _{WR1} t _{WR2}	5 12		5 12		ns	12 13
Output High-Z from $\overline{\text{WE}}$	t _{ODW}		25		35	ns	5
Output Active from $\overline{\text{WE}}$	t _{OE_W}	5		5		ns	5
Data Setup Time	t _{DS}	30		40		ns	4
Data Hold Time	t _{DH1} t _{DH2}	0 7		0 7		ns	12 13

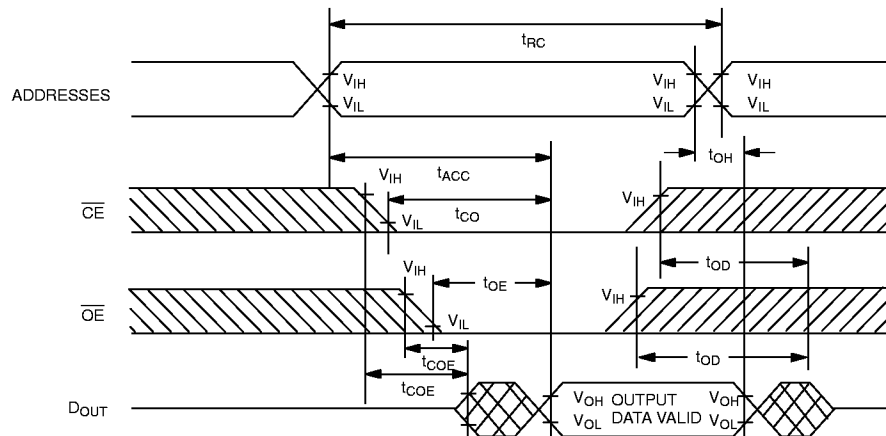
READ CYCLE

SEE NOTE 1

WRITE CYCLE 1

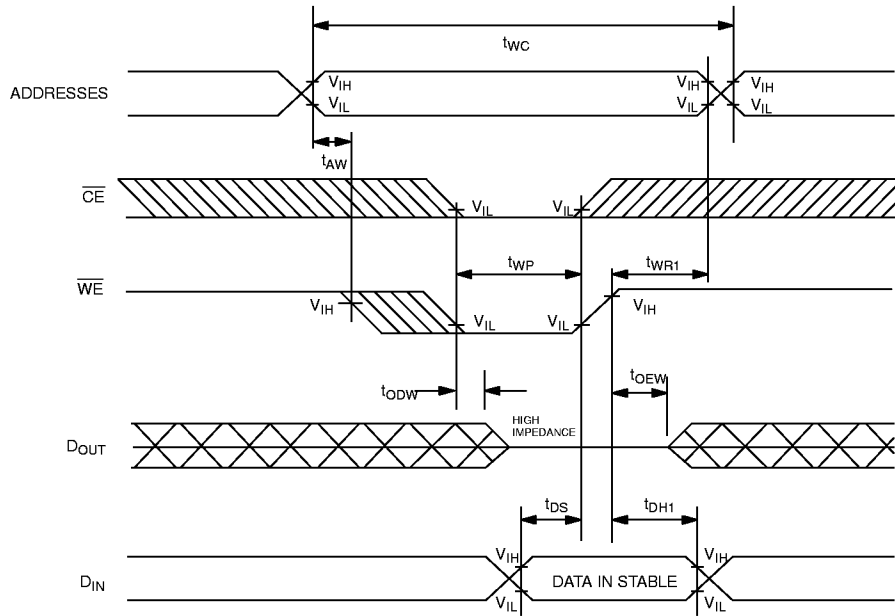

SEE NOTES 2, 3, 4, 6, 7, 8 AND 12

WRITE CYCLE 2

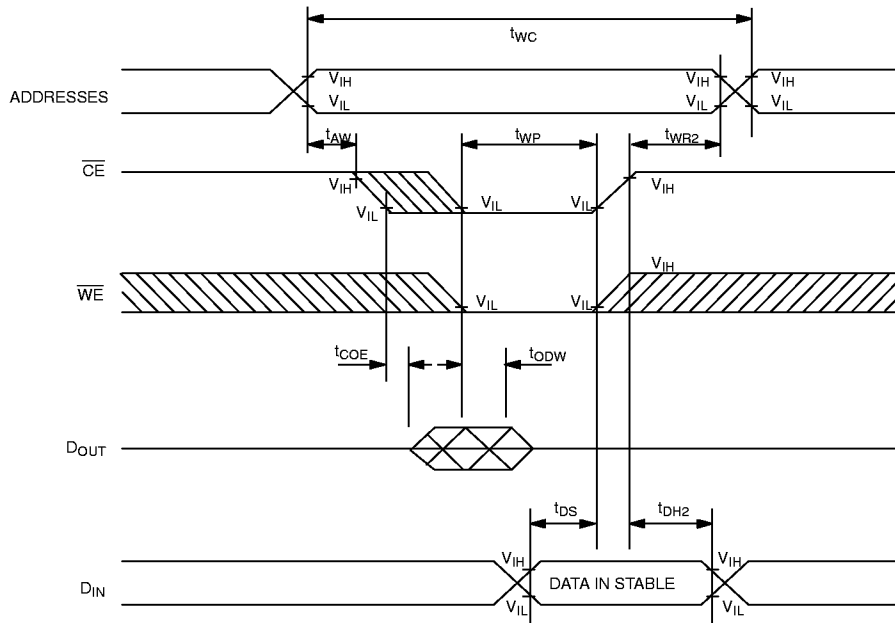

SEE NOTES 2, 3, 4, 6, 7, 8 AND 13

POWER-DOWN/POWER-UP CONDITION

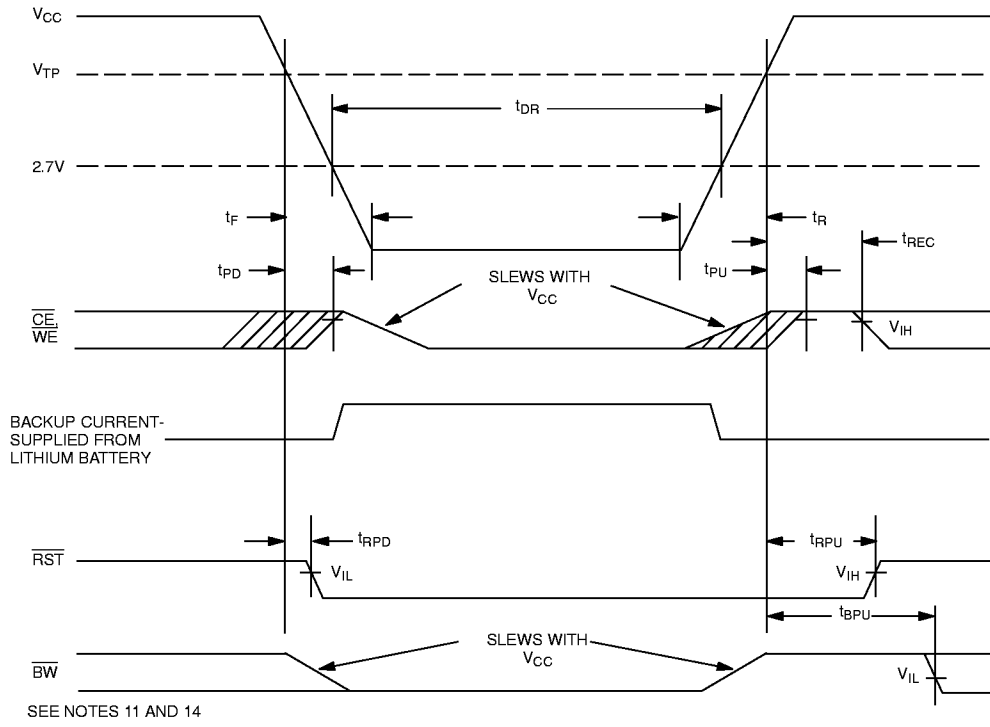

BATTERY WARNING DETECTION

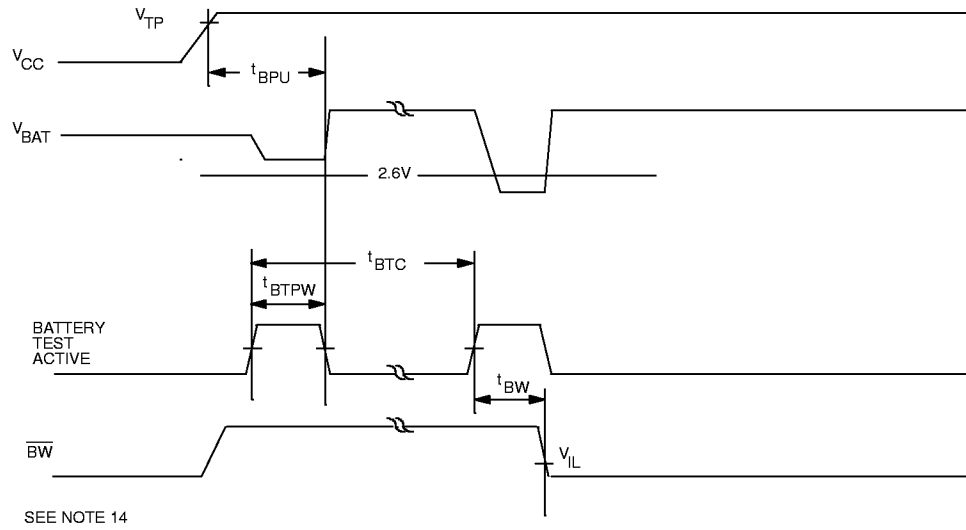

POWER-DOWN/POWER-UP TIMING(t_A: See Note 10)

PARAMETER	SYMBOL	MIN	TYP	MAX	UNITS	NOTES
V _{CC} Fail Detect to \overline{CE} and \overline{WE} Inactive	t _{PD}			1.5	μs	11
V _{CC} slew from V _{TP} to 0V	t _F	150			μs	
V _{CC} Fail Detect to \overline{RST} Active	t _{RPD}			15	μs	14
V _{CC} slew from 0V to V _{TP}	t _R	150			μs	
V _{CC} Valid to \overline{CE} and \overline{WE} Inactive	t _{PU}			2	ms	
V _{CC} Valid to End of Write Protection	t _{REC}			125	ms	
V _{CC} Valid to \overline{RST} Inactive	t _{RPU}	150	200	350	ms	14
V _{CC} Valid to \overline{BW} Valid	t _{BPU}			1	s	14

BATTERY WARNING TIMING(t_A: See Note 10)

PARAMETER	SYMBOL	MIN	TYP	MAX	UNITS	NOTES
Battery Test Cycle	t _{BTC}		24		hr	
Battery Test Pulse Width	t _{BTPW}			1	s	
Battery Test to \overline{BW} Active	t _{BW}			1	s	

(t_A = 25°C)

PARAMETER	SYMBOL	MIN	TYP	MAX	UNITS	NOTES
Expected Data Retention Time	t _{DR}	10			years	9

WARNING:

Under no circumstance are negative undershoots, of any amplitude, allowed when device is in battery backup mode.

NOTES:

- \overline{WE} is high for a Read Cycle.
- $\overline{OE} = V_{IH}$ or V_{IL} . If $\overline{OE} = V_{IH}$ during write cycle, the output buffers remain in a high impedance state.
- t_{WP} is specified as the logical AND of \overline{CE} and \overline{WE} . t_{WP} is measured from the latter of \overline{CE} or \overline{WE} going low to the earlier of \overline{CE} or \overline{WE} going high.
- t_{DS} is measured from the earlier of \overline{CE} or \overline{WE} going high.
- These parameters are sampled with a 5 pF load and are not 100% tested.
- If the \overline{CE} low transition occurs simultaneously with or later than the \overline{WE} low transition, the output buffers remain in a high impedance state during this period.
- If the \overline{CE} high transition occurs prior to or simultaneously with the \overline{WE} high transition, the output buffers remain in high impedance state during this period.
- If \overline{WE} is low or the \overline{WE} low transition occurs prior to or simultaneously with the \overline{CE} low transition, the output buffers remain in a high impedance state during this period.

9. Each DS1345 has a built-in switch that disconnects the lithium source until V_{CC} is first applied by the user. The expected t_{DR} is defined as accumulative time in the absence of V_{CC} starting from the time power is first applied by the user.
10. All AC and DC electrical characteristics are valid over the full operating temperature range. For commercial products, this range is 0°C to 70°C. For industrial products (IND), this range is -40°C to +85°C.
11. In a power down condition the voltage on any pin may not exceed the voltage on V_{CC} .
12. t_{WR1} and t_{DH1} are measured from \overline{WE} going high.
13. t_{WR2} and t_{DH2} are measured from \overline{CE} going high.
14. \overline{RST} and \overline{BW} are open-drain outputs and cannot source current. External pull-up resistors should be connected to these pins for proper operation. Both pins will sink 10 mA.

DC TEST CONDITIONS

Outputs Open
 Cycle = 200 ns for operating current
 All voltages are referenced to ground

AC TEST CONDITIONS

Output Load: 100 pF + 1TTL Gate
 Input Pulse Levels: 0 – 3.0V
 Timing Measurement Reference Levels
 Input: 1.5V
 Output: 1.5V
 Input pulse Rise and Fall Times: 5 ns

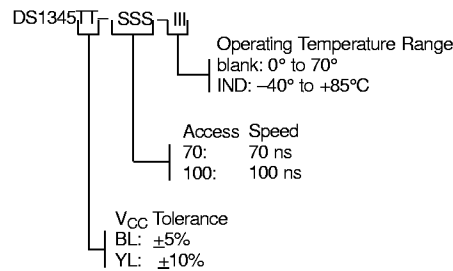
ORDERING INFORMATION

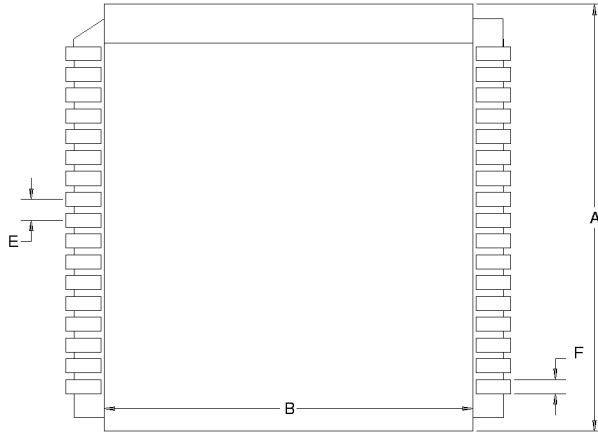
D1345YL/BL 34-PIN LOW PROFILE MODULE (LPM)

PKG	INCHES	
	DIM	MIN
A	0.955	0.980
B	0.840	0.855
C	0.230	0.250
D	0.975	0.995
E	0.047	0.053
F	0.015	0.025

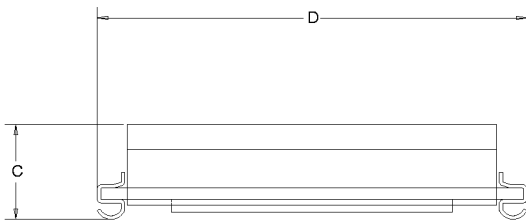

Dallas Semiconductor Low Profile Modules must be inserted into 68-pin PLCC sockets for proper operation. Direct surface-mounting of these products by reflow soldering will destroy internal lithium batteries.

For recommended PLCC sockets, contact the Dallas Semiconductor factory.